

## ISA-PLAN® - SMD Präzisionswiderstände / SMD precision resistors

TECHNISCHE DATEN / TECHNICAL DATA		
Widerstandswerte	Resistance values	3 mOhm - 1 Ohm
Toleranz	Tolerance	0.5 %*, 1 %, 5 %
Temperaturkoeffizient	Temperature coefficient	< 50 ppm/K (20 °C - 60 °C)
Temperaturbereich	Applicable temperature range	-55 °C bis/to +170 °C
Belastbarkeit	Load capacity	2 W
Innerer Widerstand ( $R_{thi}$ )	Internal heat resistance ( $R_{thi}$ )	< 30 K/W
Isolationsspannung	Dielectric withstanding voltage	200 V AC/DC
Induktivität	Inductance	< 3 nH
Stabilität (Nennlast) Abweichung $T_K =$ Kontaktstellentemperatur / Stability (Nominal load) deviation $T_K =$ Terminal temperature		< 0.5 % nach/after 2000 h ( $T_K = 80 °C$ ) / < 1.0 % nach/after 2000 h ( $T_K = 110 °C$ )

\* auf Anfrage / upon request

### MERKMALE / FEATURES

- 2 W Dauerleistung bei 110 °C  
2 W permanent power at 110 °C
- Dauerströme bis 25 A (3 mOhm)  
Constant current up to 25 A (3 mOhm)
- Sehr hohe Pulsbelastbarkeit  
High pulse power rating
- Sehr gute Langzeitstabilität  
Excellent long term stability
- Bauteilemontage: Reflow- und IR-Löten  
Mounting: Reflow- and IR-soldering
- AEC-Q200 qualifiziert  
AEC-Q200 qualified

### APPLIKATIONEN / APPLICATION

- Messwiderstand für Leistungshybride  
Current sensor for power hybrid applications
- Steuergeräte in der Automobiltechnik  
Control systems for the automotive market
- Leistungsmodul  
Power modules
- Frequenzrichter  
Frequency converters
- Schaltnetzteile  
Switch mode power supplies

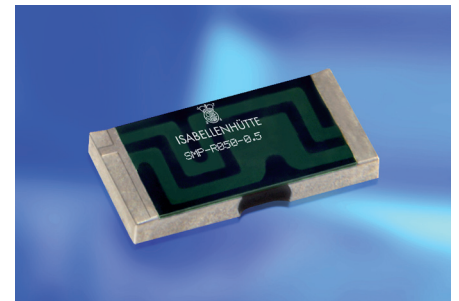

Bauform / Size 2010

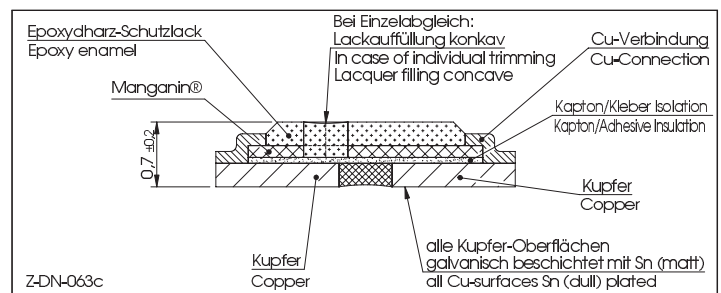
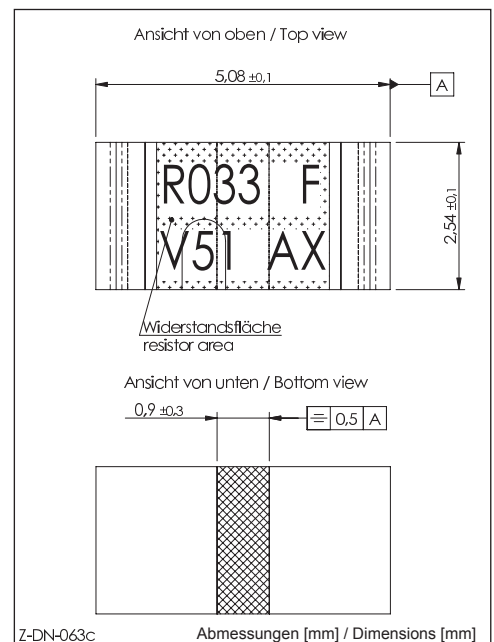

## TK, Lastminderung und Langzeitstabilität / TCR, power derating and long term stability

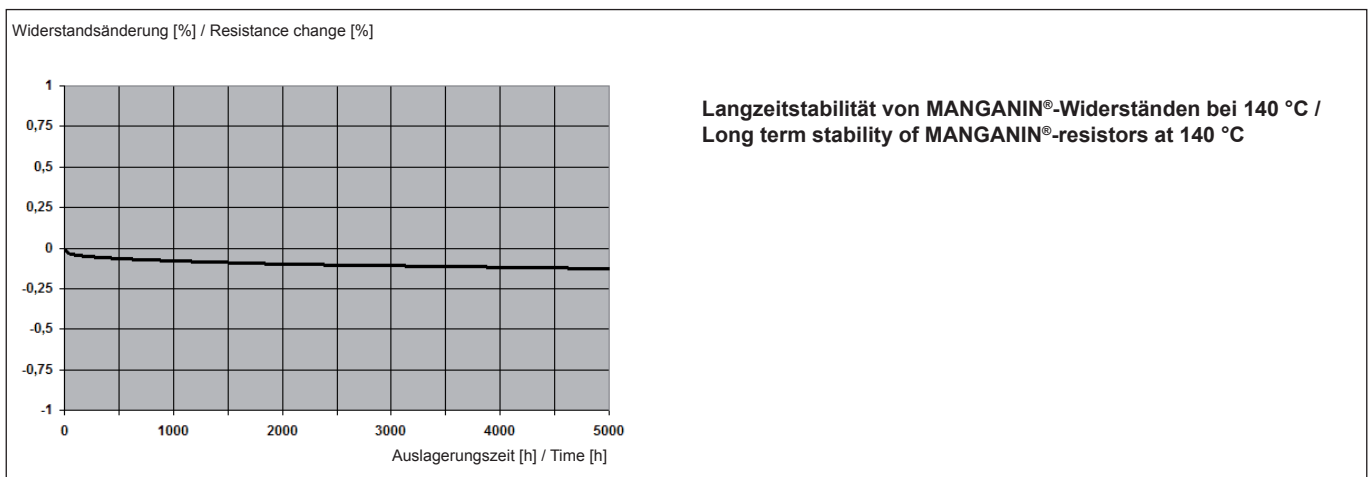
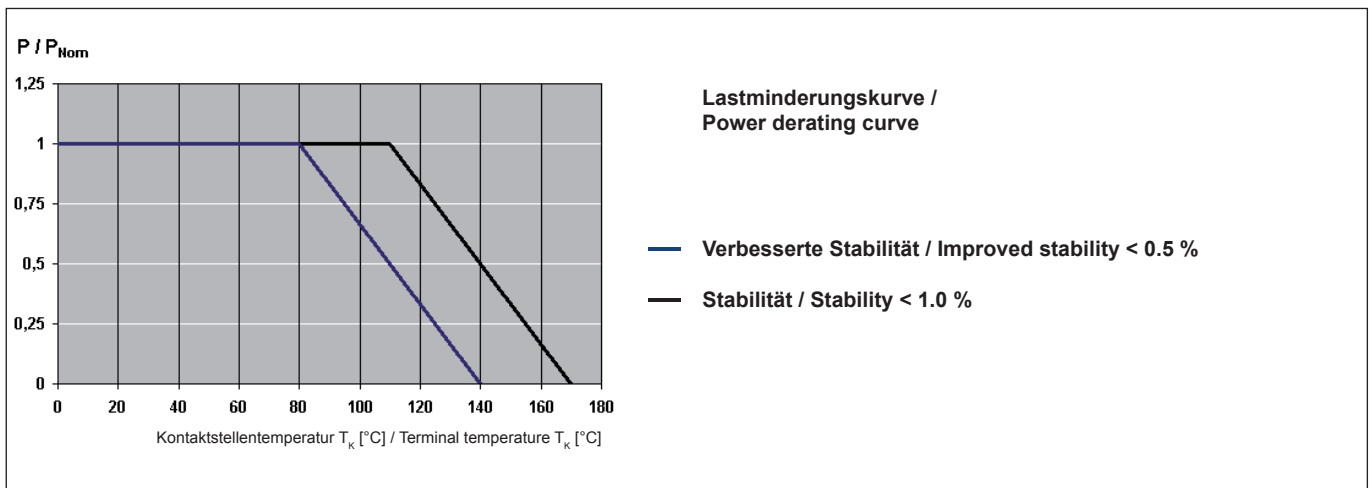
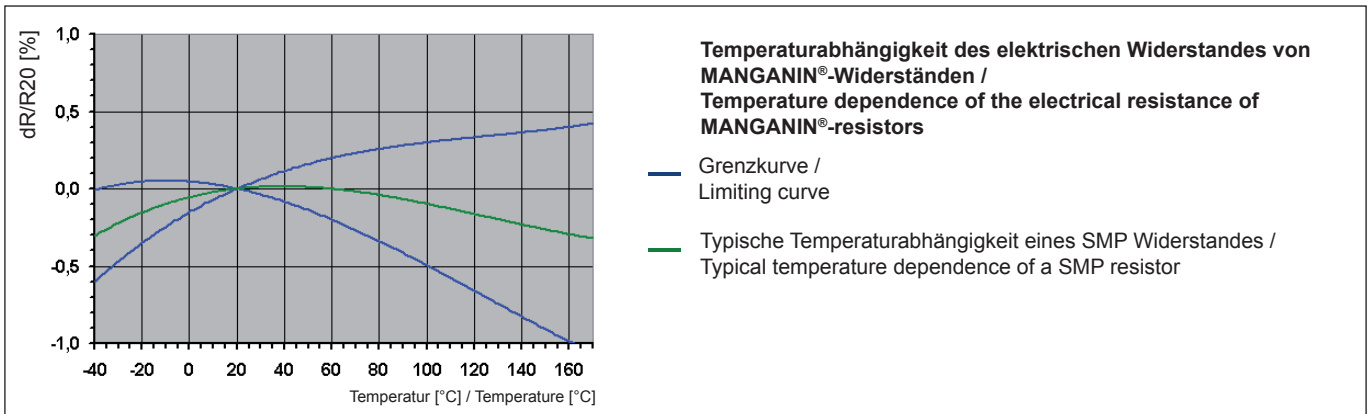

## Vorschlag für Leiterplatten Layout (Reflowlöten) / Proposal for pcb-layout (Reflow-soldering)

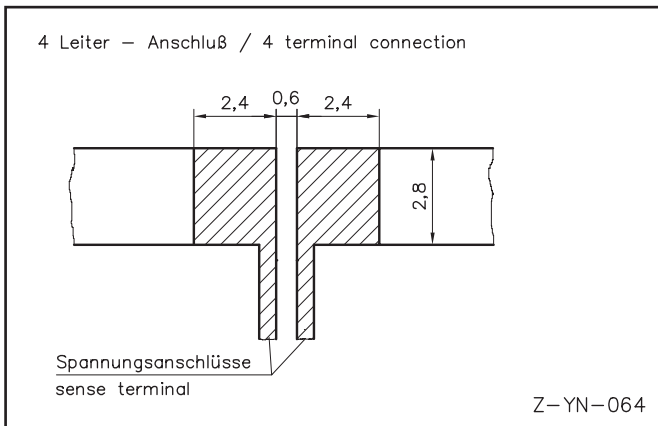

Abmessungen [mm] / Dimensions [mm]

Lötprofil Vorschlag / Recommended solder profile			
Reflow-, IR-Löten / Reflow-, IR-soldering			
Temperatur / Temperature [°C]	260	255	217
Zeit / Time [s]	peak	40	90
<b>RoHS 2002/95/EG konform seit Produktstart.</b> Ausführliche Informationen erhalten Sie auf unserer Homepage: <a href="http://www.isabellenhuette.de">www.isabellenhuette.de</a> <b>RoHS 2002/95/EC compliance since product launch.</b> For more information please visit our website: <a href="http://www.isabellenhuette.de">www.isabellenhuette.de</a>			

Eine leichte Verformung beim Löten beeinflusst nicht die technischen Eigenschaften des Bauteils. /  
Slight deformations during soldering do not affect technical properties of the component.

GURTINFORMATIONEN / TAPE & REEL INFORMATION	
Norm / Specification	DIN EN 60286-3
Gurtbreite / Tape width	12 mm
Anzahl Bauteile / Parts per reel	10000

BESTELLBEZEICHNUNG / ORDERING CODE		
<b>SMP-R005-1.0</b>		
Typ / Type	Widerstandswert / Resistance value	Toleranz / Tolerance
SMP	5 mOhm	1.0 %

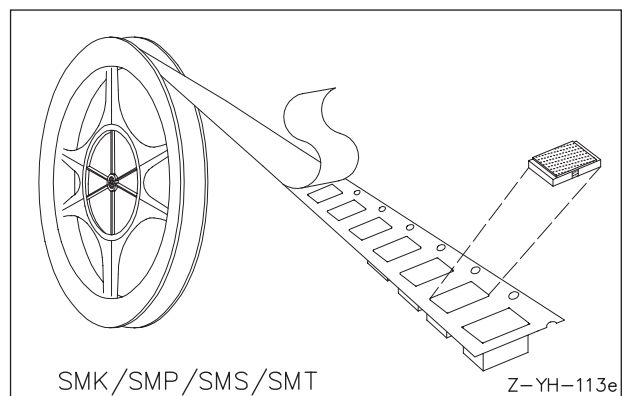

### Gewährleistung

Alle Angaben über Eignung, Verarbeitung und Anwendung unserer Produkte, technische Beratung und sonstige Angaben erfolgen nach bestem Wissen, befreien den Käufer jedoch nicht von eigenen Prüfungen und Versuchen.

### Warranty

All information regarding the suitability, workability and applicability of our products, all technical advice and other information are provided to the best of our knowledge and belief, but shall not discharge the buyer from his own examinations and tests.



**Grenzkurve für maximale Pulsenergie bzw. Pulsleistung für Dauerbetrieb /  
Maximum pulse energy respectively pulse power for continuous operation**

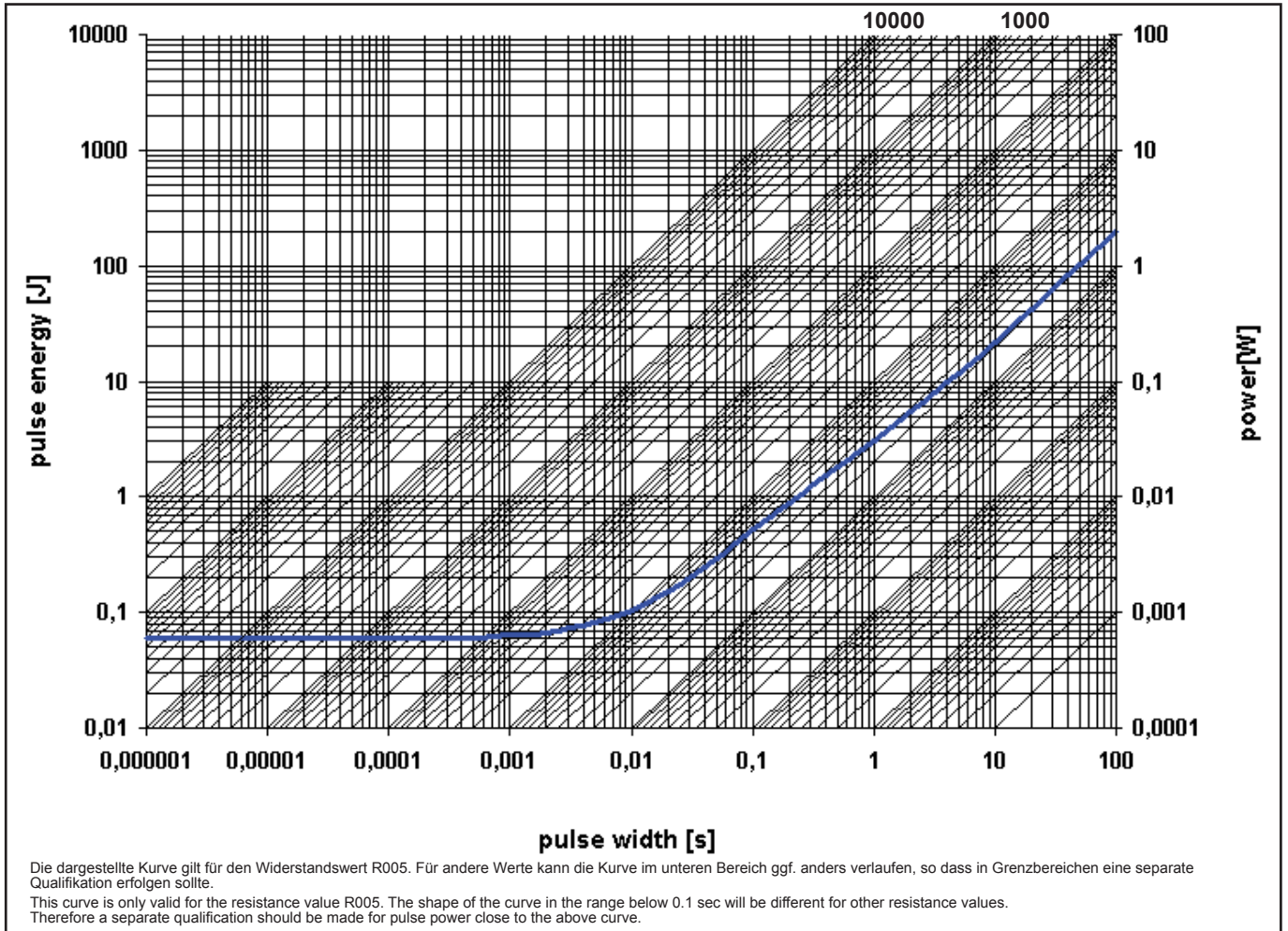

Spezifikation / Specification AEC-Q200			
Parameters	Test Conditions	Specification	Typical data
Maximum Temperature for full power operation	90 °C	90 °C	90 °C
Working Temperature	-55 to 170 °C	-55 to 170 °C	-55 to 170 °C
Thermal Shock	MIL-STD-202 method 107-B1	0.1 %	0.1 %
Overload	MIL-R-26E (5 times rated power, 5 sec)	0.2 %	0.2 %
Solderability	MIL-STD-202 method 208	> 95 % coverage	> 95 % coverage
Resistance to Solvents	MIL-STD-202 method 215, 2.1a, 2.1d	no damage	no damage
Low Temperature Storage and Operation	MIL-STD-26E	0.1 %	0.05 %
Resistance to Soldering Heat	MIL-STD-202 method 210	0.1 %	0.05 %
Moisture Resistance	MIL-STD-202 method 106	0.1 %	0.05 %
Shock	MIL-STD-202 method 213-A	0.2 %	0.1 %
Vibration, High Frequency	MIL-STD-202 method 204-B	0.2 %	0.1 %
Life	MIL-STD-26E	0.5 %	0.2 %
Storage Life at Elevated Temperature	MIL-STD-202 method 108-F	0.5 %	0.3 %
High Temperature Exposure	140 °C, 2000 h	0.5 %	0.2 %
Current Noise	MIL-STD-202 method 308	0.01 %	0.01 %
Voltage Coefficient (%/V)	MIL-STD-202 method 309	linearity error less than 120dB	linearity error less than 120dB
Resistance Temperature Characteristic	MIL-STD-202 method 304 (20-60°C)	<50 ppm/K	<30 ppm/K
Thermal EMF	0 - 100 °C	2 µV/ K max.	0.5 µV/ K max.
Frequency Characteristic R<25 mOhm	inductivity	< 3 nH	< 1 nH