

## ISA-WELD® - Präzisionswiderstände / Precision resistors

TECHNISCHE DATEN / TECHNICAL DATA		
Widerstandswerte	Resistance values	0.3, 0.5, 1, 2 mOhm
Toleranz	Tolerance	3 %, 5 %
Temperaturkoeffizient	Temperature coefficient	siehe Tabelle/see table
Temperaturbereich	Applicable temperature range	-55 °C bis/to +170 °C
Belastbarkeit	Load capacity	5 W
Innerer Wärmewiderstand ( $R_{thi}$ )	Internal heat resistance ( $R_{thi}$ )	ab/from 4 K/W *
Induktivität	Inductance	< 3 nH
Stabilität (Nennlast) Abweichung $T_K$ = Kontaktstellentemperatur / Stability (Nominal load) deviation $T_K$ = Terminal temperature		< 0.5 % nach/after 2000 h ( $T_K$ = 105 °C) < 1.0 % nach/after 2000 h ( $T_K$ = 135 °C)

\* siehe Tabelle Seite 3 / see table on page 3

### MERKMALE / FEATURES

- 5 W Dauerleistung  
5 W permanent power
- Dauerströme bis 100 A (0,3 mOhm)  
Continuous current load up to 100 A (0.3 mOhm)
- Sehr gute Langzeitstabilität  
Excellent long term stability
- Massive Kupferanschlüsse  
Heavy copper connectors
- Geeignet für Löttemperaturen bis 350 °C / 30 sek  
Max. solder temperature up to 350 °C / 30 sec
- AEC-Q200 qualifiziert  
AEC-Q200 qualified

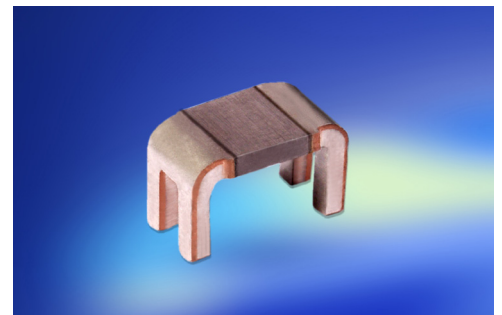

Bauform / Size 3820

### APPLIKATIONEN / APPLICATION

- Hochstromanwendungen in der Automobiltechnik  
High current applications for the automotive market
- Frequenzumrichter  
Frequency converters
- Leistungsmodule  
Power modules
- Elektrowerkzeuge  
Power tools

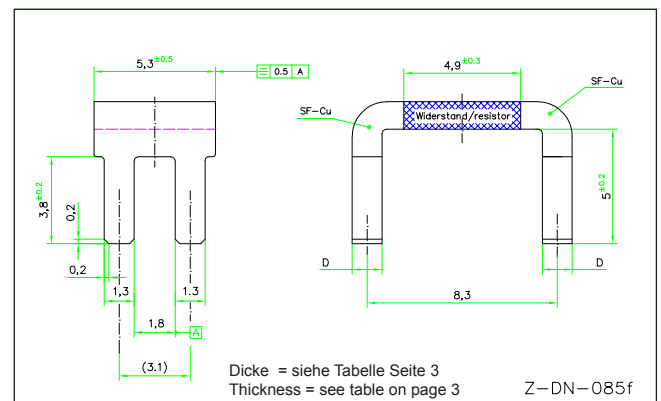

Abmessungen [mm] / Dimensions [mm]

## TK, Lastminderung und Langzeitstabilität / TCR, power derating and long term stability

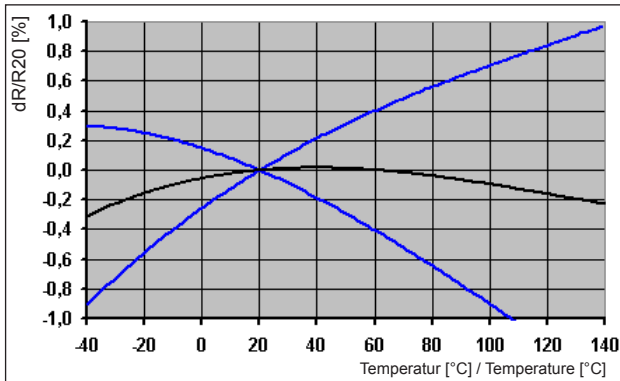

**Temperaturabhängigkeit des elektrischen Widerstandes von MANGANIN®-Widerständen / Temperature dependence of the electrical resistance of MANGANIN®-resistors**

- Grenzkurve  
Limiting curve
- Typische Temperaturabhängigkeit eines BVH Widerstandes  
Typical temperature dependence of a BVH resistor

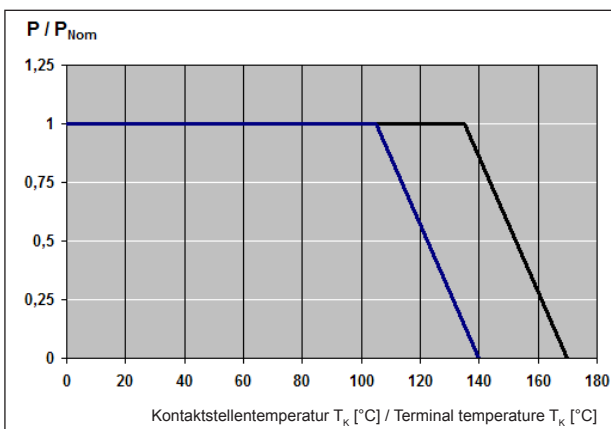

**Lastminderungskurve (BVH-M-R0005) / Power derating curve (BVH-M-R0005)**

- Verbesserte Stabilität / Improved stability 0.5 %
- Stabilität / Stability 1.0 %

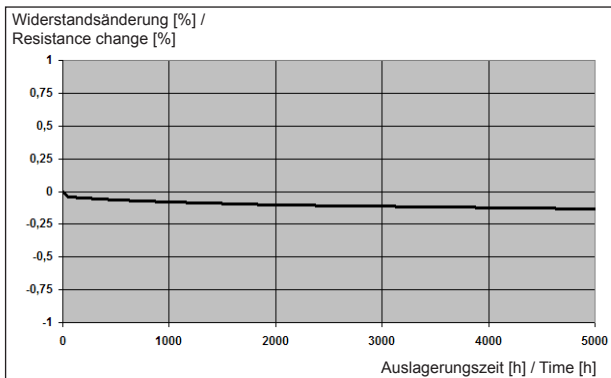

**Langzeitstabilität von MANGANIN®-Widerständen bei 140 °C  
Typischer Kurvenverlauf /**

**Long term stability of MANGANIN®-resistors at 140 °C  
Typical run of the curve**

## Montagehinweis / Proposal for mounting

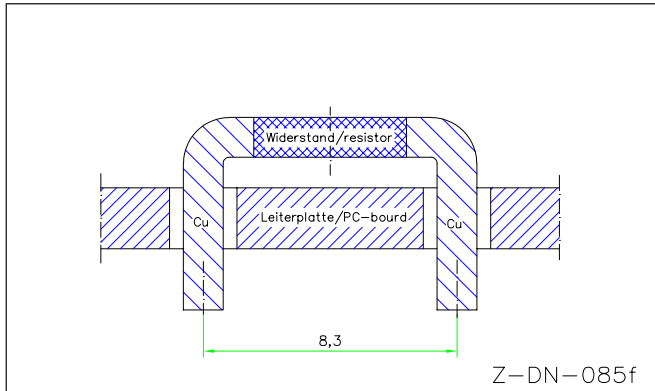

## Vorschlag für Leiterplatten Layout / Proposal for pcb-layout

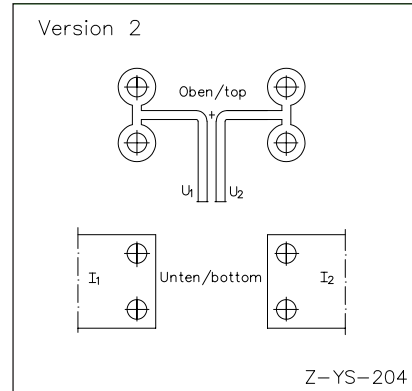

Lötprofil Vorschlag / Recommended solder profile			
Reflow-, IR-löten / Reflow-, IR-soldering			
Temperatur / Temperature [°C]	260	255	217
Zeit / Time [s]	Peak	40	90

VERPACKUNG / PACKAGING
Schüttgut in Folienbeutel 500 St. evakuiert und rückbegast
500 pcs. sealed in plastic bags evacuated and refilled with dry nitrogen

BESTELLBEZEICHNUNG / ORDERING CODE			
<b>BVH-M-R0005-5.0</b>			
Typ / Type	Material	Widerstandswert / Resistance value	Toleranz / Tolerance
BVH	MANGANIN®	0.5 mOhm	5 %

Typ / Type	Wert/mΩ / Value/mΩ	Material	Dicke (D) / mm / Thickness (D) / mm	R <sub>thi</sub> K/W / R <sub>thi</sub> K/W	TK/ppm/K / TC/ppm/K	Watt
BVH-M-R0003	0.3	MANGANIN®	1.42	4	<300	5
BVH-M-R0005	0.5	MANGANIN®	0.86	7	<300	5
BVH-A-R001	1	Aluchrom	1.30	8	<100	5
BVH-A-R002	2	Aluchrom	0.64	15	<100	4

**RoHS 2002/95/EG konform seit Produktstart.**  
 Ausführliche Informationen erhalten Sie auf unserer Homepage:  
[www.isabellenhuette.de](http://www.isabellenhuette.de)

**RoHS 2002/95/EC compliance since product launch.**  
 For more information please visit our website:  
[www.isabellenhuette.de](http://www.isabellenhuette.de)

### Gewährleistung

Alle Angaben über Eignung, Verarbeitung und Anwendung unserer Produkte, technische Beratung und sonstige Angaben erfolgen nach bestem Wissen, befreien den Käufer jedoch nicht von eigenen Prüfungen und Versuchen.

### Warranty

All information regarding the suitability, workability and applicability of our products, all technical advice and other information are provided to the best of our knowledge and belief, but shall not discharge the buyer from his own examinations and tests.

## Grenzkurve für maximale Pulsenergie bzw. Pulsleistung für Dauerbetrieb / Maximum pulse energy respectively pulse power for continuous operation

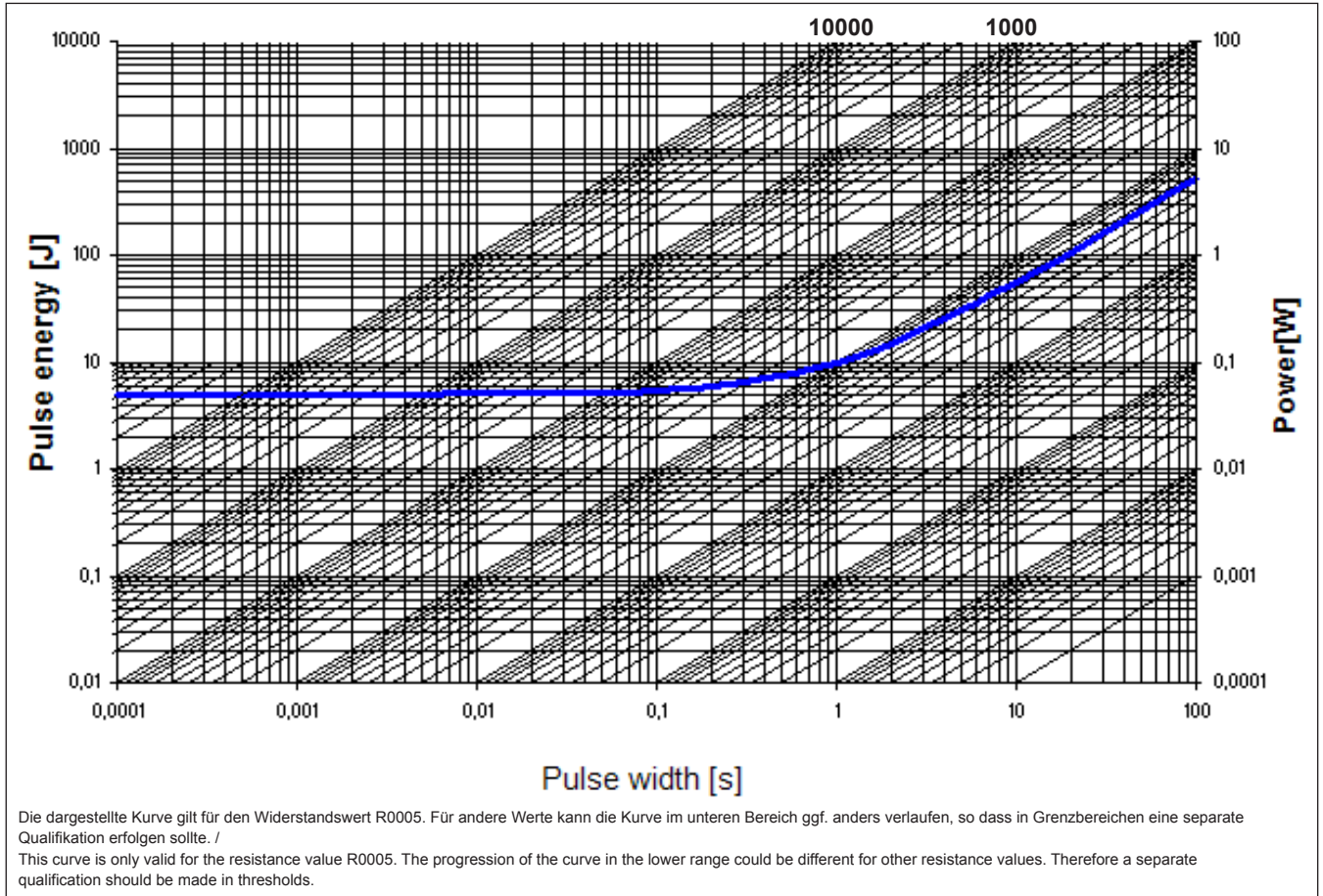

Spezifikation / Specification			
Parameters	Test Conditions	Specification	Typical data
Maximum Temperature for full power operation	140 °C	140 °C	140 °C
Working Temperature	-55 to 170 °C	-55 to 170 °C	-55 to 170 °C
Thermal Shock	MIL-STD-202 method 107-B1	0.1 %	0.05 %
Overload	MIL-R-26E (5 times rated power, 5 sec)	0.2 %	0.01 %
Solderability	MIL-STD-202 method 208	> 95 % coverage	100 % coverage
Resistance to Solvents	MIL-STD-202 method 215, 2.1a, 2.1d	no damage	no damage
Low Temperature Storage and Operation	MIL-STD-26E	0.1 %	0.05 %
Resistance to Soldering Heat	MIL-STD-202 method 210	0.1 %	0.02 %
Moisture Resistance	MIL-STD-202 method 106	0.1 %	0.01 %
Shock	MIL-STD-202 method 213-A	0.2 %	0.02 %
Vibration, High Frequency	MIL-STD-202 method 204-B	0.2 %	0.05 %
Life	MIL-STD-26E	0.2 %	0.1 %
Storage Life at Elevated Temperature	MIL-STD-202 method 108-F	0.3 %	0.15 %
High Temperature Exposure	140 °C, 2000 h	0.5 %	0.2 %
Current Noise	MIL-STD-202 method 308	0.01 %	< 0.001 %
Voltage Coefficient (%/V)	MIL-STD-202 method 309	linearity error less than 120dB	linearity error less than 120dB
Resistance Temperature Characteristic	MIL-STD-202 method 304 (20-60°C)	<100 ppm/K	<50 ppm/K
Thermal EMF	0 - 100 °C	1 µV/ K max.	0.05 µV/ K max.
Frequency Characteristic	inductivity	< 3 nH	< 1 nH